

Alexis

Caratteristiche Features



- Rivestimenti in tessuto completamente sfoderabili.
Fully removable fabric covers.
- Cuscini schienale in FILPIUMA (speciale miscela soffice e ipoallergenica composta da vera piuma e fibra siliconata cava) con inserto in poliuretano espanso, il tutto ricoperto di tessuto a tenuta di piuma.
Back cushions in FILPIUMA (special soft and hypoallergenic mixture composed of real feather and hollow silicone fiber) with insert in polyurethane foam, all covered with feather-tight fabric.
- Struttura in legno e derivati con imbottitura in poliuretano espanso, il tutto rivestito in vellutino.
Structure in wood and derivatives with polyurethane foam padding, all covered in velvet.
- Cuscini seduta in poliuretano espanso (D30), accoppiato ad un trapuntino in vera piuma, il tutto ricoperto in tessuto a tenuta di piuma.
Seat cushions in polyurethane foam (D30), combined with a quilt in real feather, all covered in feather-proof fabric.
- Piedi singoli in metallo lucidato o bronzato oppure a slitta verniciati grigio medio opaco.
Single feet in polished or bronzed metal or sled painted matt medium gray.

Variazioni Variations



PIEDE SINGOLO IN METALLO LUCIDATO O BRONZATO
SINGLE FOOT IN POLISHED OR BRONZED METAL



PIEDE A SLITTA VERNICIATO GRIGIO MEDIO OPACO
SLED FOOT PAINTED MATT MEDIUM GRAY

Piedi singoli in metallo lucidato o bronzato oppure a slitta verniciati grigio medio opaco.

Si prega di specificare le finiture al momento dell'ordine.

*Single feet in polished metal or sled painted matt medium gray.
Please specify finishings upon order.*

Elementi Elements

ALECD194

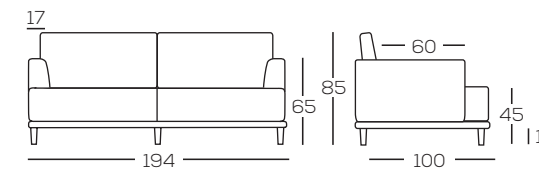

ALECD214

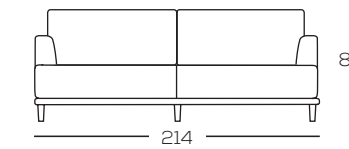

ALECD234

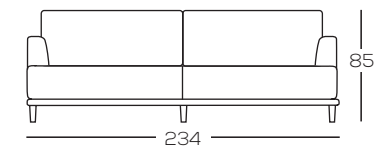

ALECT177 Dx/Sx

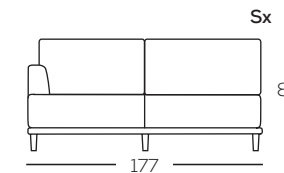

ALECT197 Dx/Sx

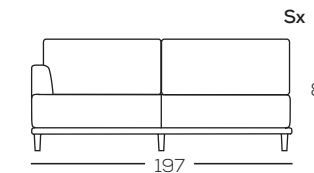

ALECT217 Dx/Sx

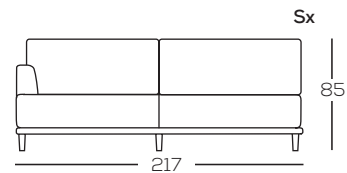

ALECR225 Dx/Sx

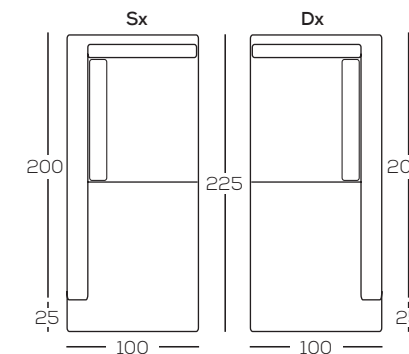

ALECPF100

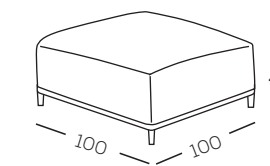

ALECCS40

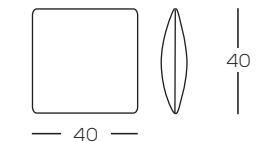

ALECCF50

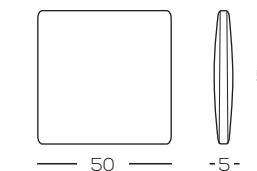

ALECCF80

