

Boss

Caratteristiche
Features

- Rivestimenti in tessuto completamente sfoderabili.
Fully removable fabric covers.
- Cuscini schienale in filpiuma (speciale miscela soffice ed ipoallergenica composta da vera piuma e fibra siliconata cava), il tutto ricoperto di tessuto in puro cotone a tenuta di piuma.
Back cushions in filpiuma (special soft and hypoallergenic mixture composed of real feather and hollow silicone fiber), all covered in pure cotton fabric with feather hold.
- Sedute monoscocca in poliuretano espanso a quote differenziate accoppiato ad un trapuntino in piuma, il tutto ricoperto di tessuto in puro cotone a tenuta di piuma.
Monocoque seats in differentiated-density polyurethane foam coupled with a feather quilt, all covered in feather-tight pure cotton fabric.
- Struttura in legno e derivati leggeri con imbottitura in poliuretano espanso, il tutto rivestito in vellutino.
Structure in wood and derivatives with polyurethane foam padding, all covered in velvet.
- Piedi a scomparsa in ABS nero con inserto antiscivolo.
Invisible feet in black ABS with non-slip insert.

Variazioni
Variations

Per un corretto utilizzo i divani devono essere completati con i cuscini di schienale oppure con i cuscinetti accessori. Le cuciture praticate di serie su questo modello sono: taglio vivo (pelle), pizzicata (tessuto) e profilo in canneté in tinta o a contrasto (velluto).

A richiesta e senza maggiorazione, viene praticata una cucitura a costina che rende i rivestimenti più abbondanti, per un aspetto e una seduta più soffice e destrutturata.

Le imbottiture in piuma conferiranno al divano un aspetto più destrutturato e vissuto, le forme dei cuscini diverranno quindi più morbide.

For a correct use, the sofas must be completed with back cushions or with accessory cushions. The standard stitching on this model is: raw cut (leather), plucked (fabric) and canneté profile in the same or contrasting color (velvet).

Upon request and without price increase, a rib stitching is practiced which makes the coverings more abundant, for a softer and more unstructured appearance and seating.

The feather padding will give the sofa a more unstructured and worn look, the shapes of the cushions will therefore become softer.

Elementi
Elements

BO1CC75 prof/depth 100

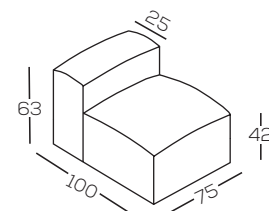

BO1CC100 prof/depth 100

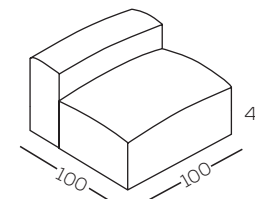

BO1CC125 prof/depth 100

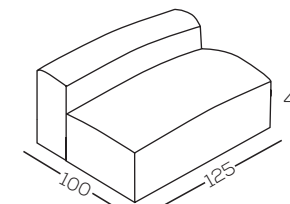

BO1CC150 prof/depth 100

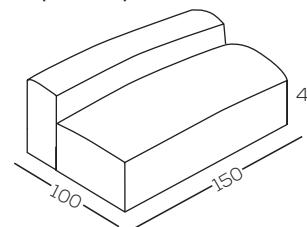

BO2CC75 prof/depth 125

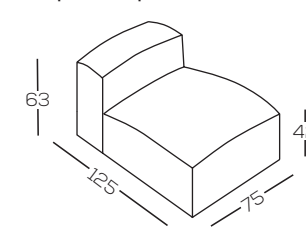

BO2CC100 prof/depth 125

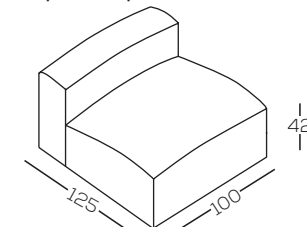

BO2CC125 prof/depth 125

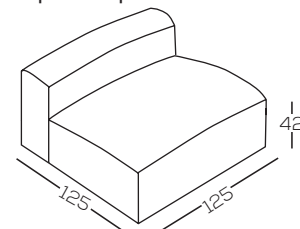

BO2CC150 prof/depth 125

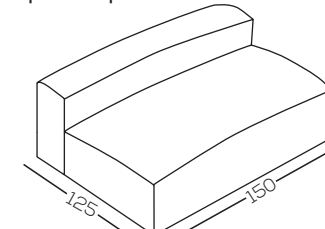

BO1CBR25A prof/depth 100

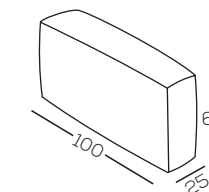

BO1CBR25B prof/depth 100

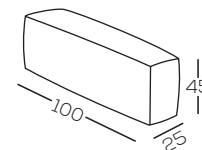

BO1CBR40A prof/depth 100

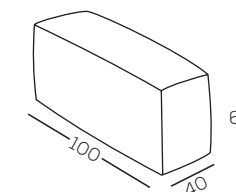

BO1CBR40B prof/depth 100

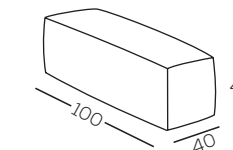

BO2CBR25A prof/depth 125

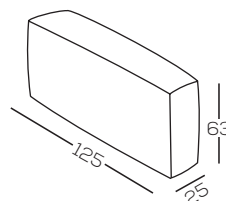

BO2CBR25B prof/depth 125

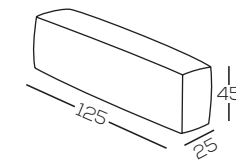

BO2CBR40A prof/depth 125

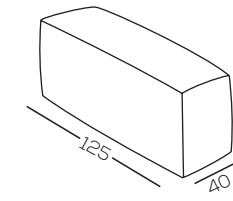

BO2CBR40B prof/depth 125

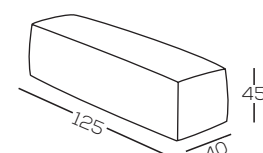

BOSCPF75

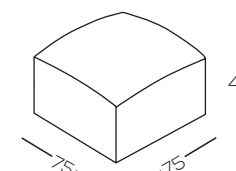

BOSCPF10075

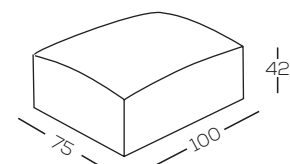

BOSCPF12575

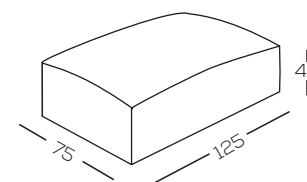

BOSCPF100

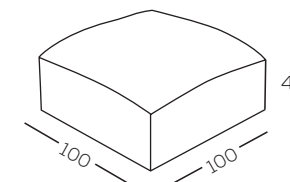

Elementi
Elements

BOSCPF125

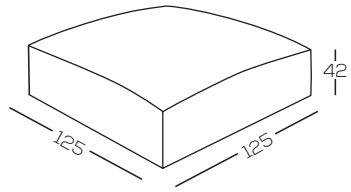

BOSCPF125100

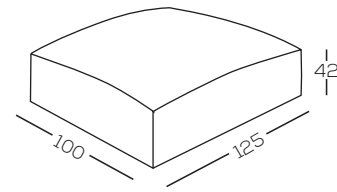

BO1CR200 Dx/Sx

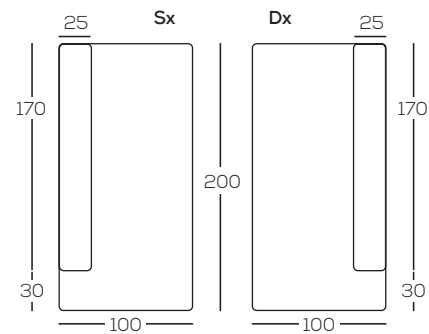

BO2CR200 Dx/Sx

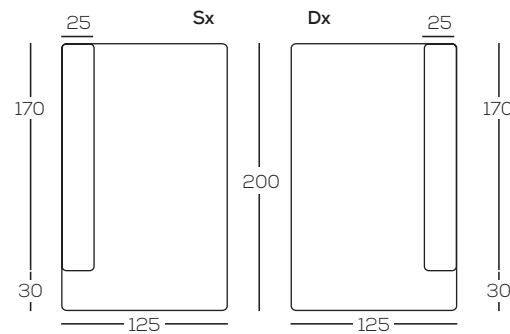

BO1CR225 Dx/Sx

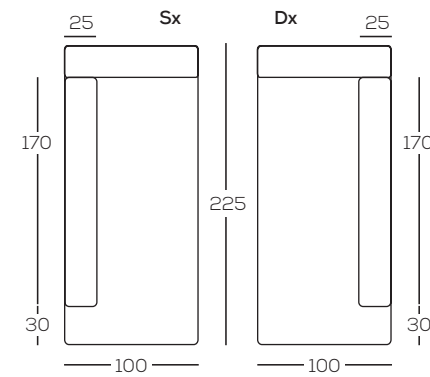

BO2CR225 Dx/Sx

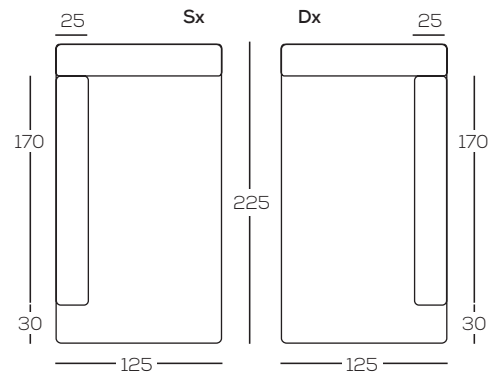

Cuscini di schienale
Back cushions

BOSCCS70

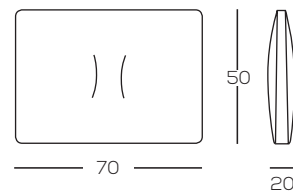

BOSCCS95

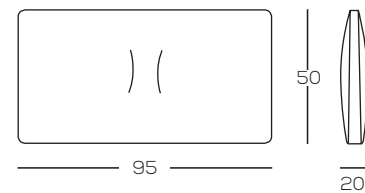

BOSCCS120

