

LIVERPOOL



STRUTTURA VERO LEGNO
REAL WOOD STRUCTURE



**SPALLIERA IN PIUMA
CON SUPPORTO IN
POLIURETANO ESPANSO**
DENSITÀ 23 KG/M³
BACK CUSHION IN
FEATHER WITH
POLYURETHANE
FOAM SUPPORT
DESITY 23 KG/M³



**CUSCINO SEDUTA IN
POLIURETANO ESPANSO**
DENSITÀ 35 KG/M³
RIVESTITA IN CLIMASOFT
SITTING CUSHION:
POLYURETHANE FOAM
DENSITY 35 KG/M³
COVERED WITH CLIMASOFT

PELLE / LEATHER

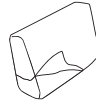

SPALLIERA SFODERABILE
REMOVABLE UPHOLSTERY
FOR BACK CUSHIONS



**CUSCINI DI SEDUTA
SFODERABILI**
REMOVABLE UPHOLSTERY
FOR SITTING CUSHIONS

TESSUTO / FABRIC

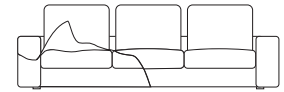

COMPLETAMENTE SFODERABILE
FULLY REMOVABLE COVERING

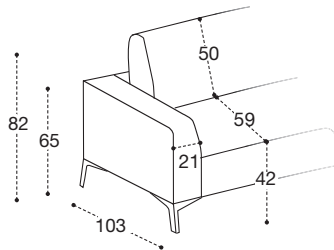

FINITURA PIEDE STANDARD STANDARD FOOT FINISHING



TITANIO LUCIDO
H. 15,5 cm

FINITURE OPTIONAL OPTIONAL FINISHINGS



INOX LUCIDO



INOX SATINATO



**CHAMPAGNE
SATINATO**



**RAL
LUCIDO/OPACO**

**FINITURE E/O PIEDI OPTIONAL NECESSITANO DI ULTERIORI DUE
SETTIMANE DI PRODUZIONE**
OPTIONAL FEET AND FINISHINGS NEED TWO ADDITIONAL WEEKS OF
PRODUCTION TIME

DIVANO
SOFA

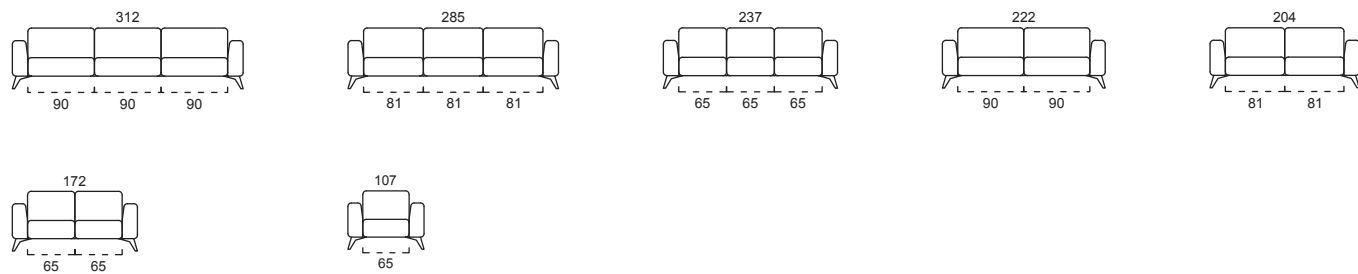

TERMINALE SX/DX
LHF/RHF SOFA

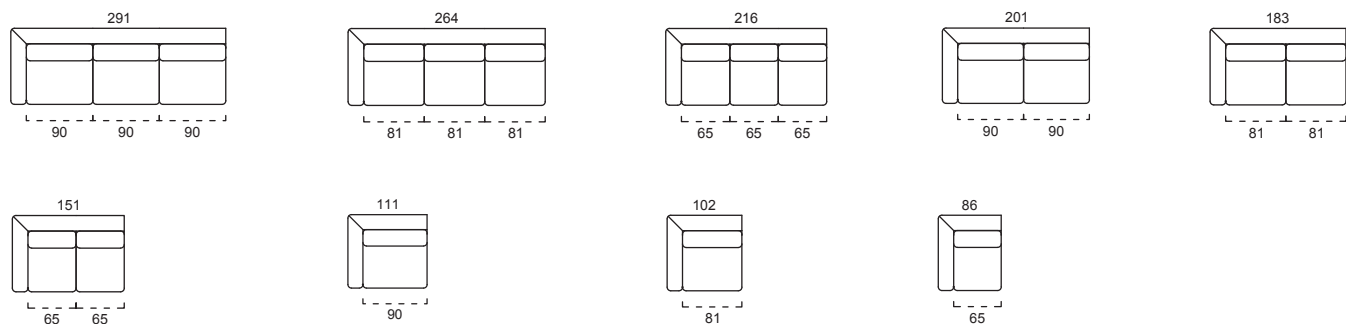

CHAISE LONGUE SX/DX
LHF/RHF CHAISE LONGUE

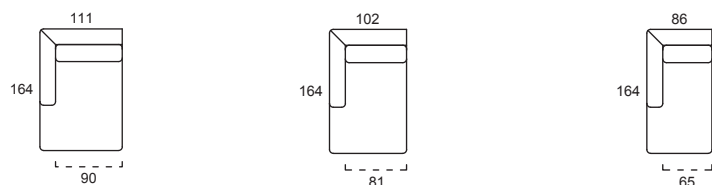

ELEMENTI SPECIALI SX/DX
LHF/RHF SPECIAL MODULES

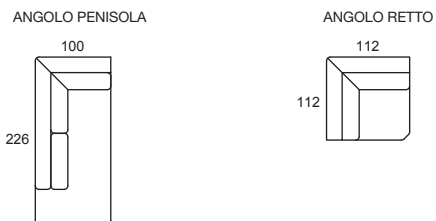

POUF
FOOTSTOOL

